

F-2001M_H(3)

MODULAR FLAKER ICE MACHINE

Item # _____

Project: _____

Qty: _____

*AutoCad available on KCL

F-2001M_H(3)

7/14

Item #13340

FLAKER DIMENSIONS

W x D x H

F-2001M_H(3)
30 x 27^{1/2} x 34^{7/16}



B-500

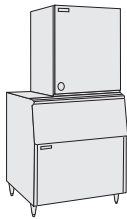

B-700

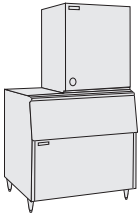

B-800

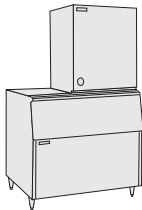

B-900

Also available on Large Bins:

B-1150SS

B-1300SS

B-1500SS

B-1650SS

*FLAKED ICE DIMENSIONS

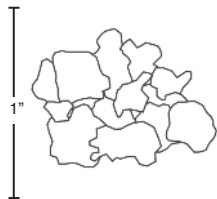

*approximate size, image not to scale



F-2001MWH

Water-Cooled
Shown on an optional
B-900

F-2001MRH

Remote 1 Phase

F-2001MRH3

Remote 3 Phase

- Up to 2030 lbs. of ice production per 24 hours
- Durable stainless steel exterior
- Advanced CleanCycle24® Design
- Removes sediment
- Cleaner ice
- Longer life and easy maintenance
- R-404A Refrigerant



Warranty

Valid in United States, Canada, Puerto Rico, & U.S. Territories. Contact factory for warranty in other countries.

Three Year - Parts & Labor on entire machine. (Serial numbers Vxxxxx) and after.)

Five Year - Parts on: Compressor, air-cooled condenser.



Hoshizaki

F-200IM_H(3) MODULAR FLAKER ICE MACHINE

DIMENSIONS
W x D x H
F-200IM_H(3)
30 x 27^{1/2} x 34^{7/16}

- Water-cooled
- Remote Air-cooled 1 Phase
- Remote Air-cooled 3 Phase

WATER-COOLED

Water Temp° F.	50°	70°	90°
Air Temp° F.			
70°	2030	1955	1915
80°	1875	1835	1795
90°	1760	1642	1685

REMOTE AIR-COOLED 1 PHASE

Water Temp° F.	50°	70°	90°
Air Temp° F.			
70°	1990	1930	1880
80°	1825	1775	1730
90°	1685	1592	1595

REMOTE AIR-COOLED 3 PHASE

Water Temp° F.	50°	70°	90°
Air Temp° F.			
70°	2010	1950	1895
80°	1845	1795	1750
90°	1700	1608	1610

UTILITY CONSUMPTION

Model Number	KWH per 100 LBS. 90/70	Potable Water Gal. per 100 lbs.
F-2001MWH	3.68	12.0
F-2001MRH	4.19	12.0
F-2001MRH3	4.33	12.0

SPECIFICATIONS

Model Number	Amperage	Min. Circuit Ampacity	Shipping Weight
F-2001MWH	16.94	30	342 lbs.
F-2001MRH	19.94	30	360 lbs.
F-2001MRH3	18.14	20	360 lbs.

STORAGE BINS

Model Number	Application Capacity	ARI-Rated Capacity
B-500	500 lbs.	360 lbs.
B-700	700 lbs.	550 lbs.
B-800	800 lbs.	600 lbs.
B-900	900 lbs.	660 lbs.
B-1150	1150 lbs.	N/A
B-1300	1275 lbs.	N/A
B-1500	1490 lbs.	N/A
B-1650	1605 lbs.	N/A

ELECTRICAL & PLUMBING/F-200IM_H(3)

- 208-230/60/1 (3 wire dedicated neutral for 115V)
- 3/8" OD copper or equivalent independent water supply with 1/4" nominal ID minimum
- 3/4" FPT independent drain connection



© HOSHIZAKI AMERICA, INC.

618 Hwy. 74 S., Peachtree City, GA 30269

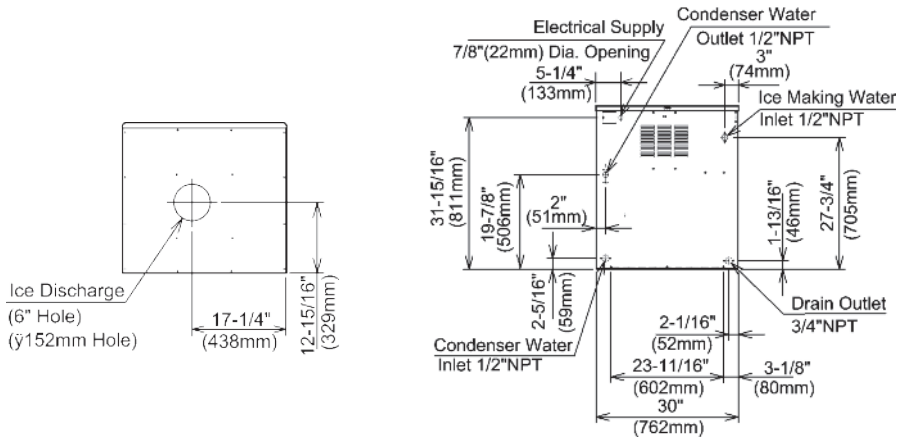
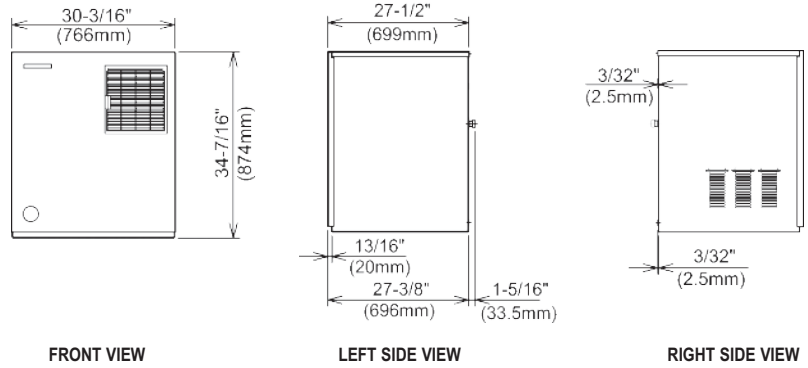

ICE DROP ZONE

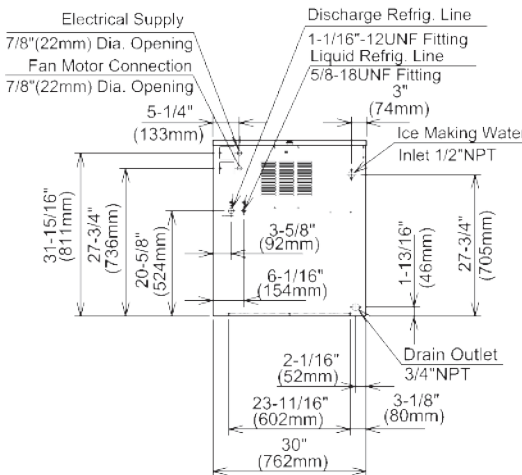

URC-22F Remote Condenser (Sold Separately)
For Use with F-2001MRH / F-2001MRH3

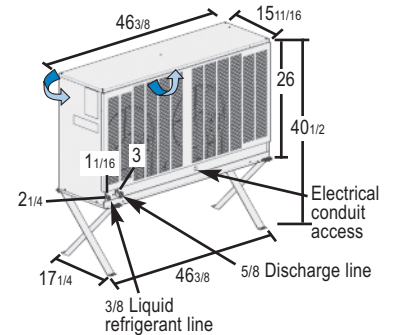

Voltage supply for the URC Remote Condenser is supplied from the Ice Maker. No additional circuit is required.

Pre-Charged Tubing Kits (Sold Separately)
20' R404-20610
35' R404-35610
55' R404-55610

OPERATING LIMITS

- Ambient Temp Range 45 - 100°F
- Water Temp Range 45 - 90°F
- Water Pressure 10 - 113psig
- Voltage Range 187 - 253V

SERVICE

- Panels easily removed and all components accessible for service.
- Removable/cleanable air filter.

TEL 1-800-438-6087

FAX 1-800-345-1325

www.hoshizaki.com

Printed in U.S.A.

